

KWO® Universal HD



1. Selection of sealing width

a. For flanges with and without raised face

Please select the nominal width of KWO® sealing tape from the table.

b. For tongue and groove flanges:

The width of the sealing tape should be equal to or less than the groove depth.

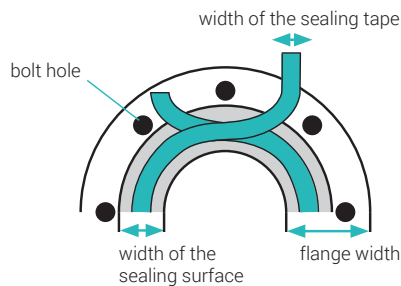

Effective sealing width (mm)	Sealing width of KWO® Universal HD (mm)
< 10	4
10 - 20	6
20 - 30	8
30 - 40	10
> 40	14

Note: Gasket stress

- To guarantee a correct sealing an engineering torque estimation is recommended. Our technical support team will gladly assist you in determining this.

2. Installation

2.1 Installation – sealing tape with nominal width of 4 and 6 mm: (overlap)

a. Preparing the flange

- Open the flange connection by a minimum of 15 cm.
- Sealing surface should be cleaned of old sealing materials and checked for damage.

b. Applying the sealing tape

- Remove the masking tape a little at a time to prevent the adhesive strip from picking up dirt. A dirty or damaged adhesive surface could cause a misplacement of the sealing tape during assembly.
- Position the start of the sealant tape close to a bolt hole (figure 1).

c. Closing the sealing tape

- Complete the installation by overlapping both ends at the starting bolt hole.
- Use a sharp knife or a pair of scissor to cut away the excess material, leaving 1 cm protruding material (figure 2).

- Note:** When the sealing tape has a nominal width of ≥ 9 mm the skive cut technique must be used since there is not enough force to compress the double thickness of the overlap joint. The skive cut technique can be always used as an alternative to the overlap technique if you are uncertain.

flanges without raised face

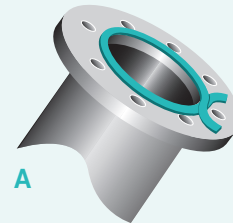

A

flanges with raised face

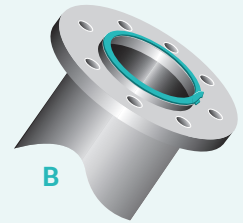

B

fragile flanges – Option 1:
To prevent the inclined position of the flange

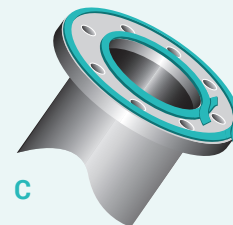

C

fragile flanges – Option 2:
To minimize the inclined position of the flange

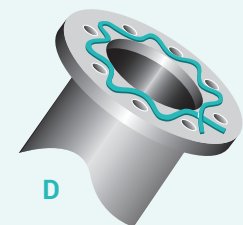

D

2.1. b Apply the sealing tape

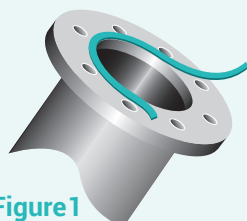

Figure 1

2.1. c Close the sealing tape

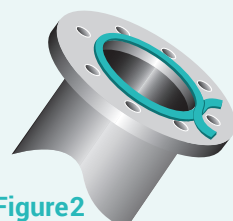

Figure 2

Container lid



E

Tongue and groove

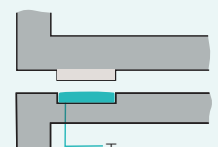

F

To ensure proper gasket compression, the tongue must be equal to or taller than the groove depth.

2.2 Installation – sealing tape with nominal width of 8, 10 and 14 mm: (skive cut)

Perform step 2.1.a and 2.1.b but with a skive cut on both ends.

a. Skive cut at the beginning

- Unwind around 0,5 m of the sealing tape and cut the end with a sharp knife by using the skive cut technique → length of the skive cut (l_s) = approx. 25 mm, angle $\alpha < 15^\circ$ (figure 3).

b. Closing skive cut

- Complete the installation by placing the sealing tape over the skived end and overlap approx. 14 mm of the sealing tape.
- For the second skive cut mark the start and end points (figure 4).
- Cut away excess material with an angle of 15 degrees. The interface should be 20% thicker than the original sealing tape (figure 5).

sealing tape

Figure 3

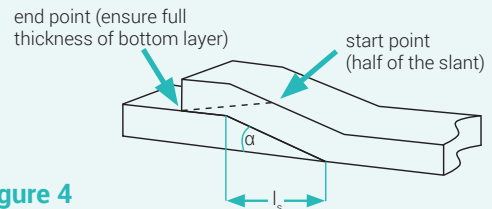
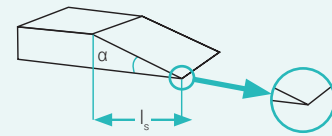

Figure 4

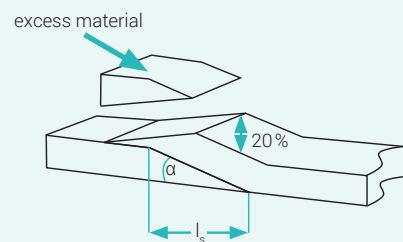
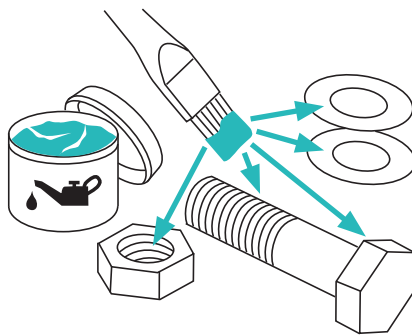

Figure 5

Note: By the selection of the tightening torque please follow the recommendations of the device manufacturer.

3. Torquing



1. Lubricate all connecting and fastening elements (screws, nuts and washers).

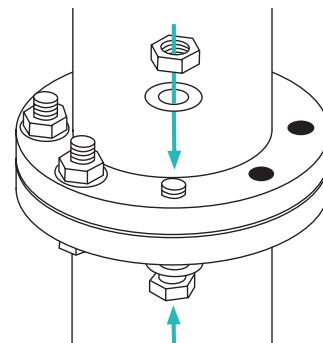

2. Install screws, nuts and washers on the flange.

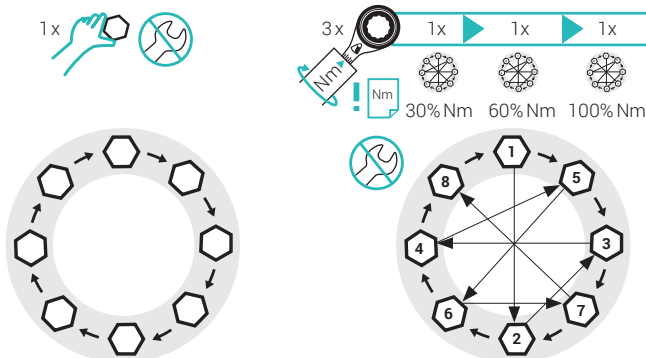

3. The screws are initially hand tightened in a sequential circular pattern.

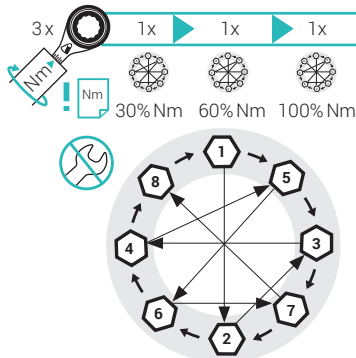

4. Tighten the screws crosswise in three phases by using a calibrated torque:

- 1st pass: 30% of target torque
- 2nd pass: 60% of target torque
- 3rd pass: 100% of target torque

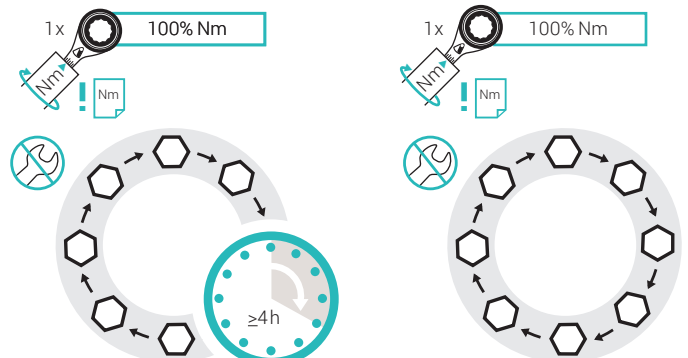

5. Tighten the screws crosswise with 100% of the torque and wait for 4 hours.

6. For final installation retighten the screws crosswise until the required torque is reached.

For further details on gasket installation, please refer to the ESA/FSA Guidelines for safe seal usage – Flanges and Gaskets, available from the Fluid Sealing Association and the European Sealing Association.

All technical information and advice given here is based on our previous experiences and/or test results. We give this information to the best of our knowledge, but assume no legal responsibility. Customers are asked to check the suitability and usability in the specific application, since the performance of the product can only be judged when all necessary operating data are available. Specifications are subject to change without notice. KWO's terms and conditions of sale apply to the purchase and sale of the product.

